

FM-704A EMI Input Filter and Transient Suppression Module

28 VOLT INPUT – 40 WATT

FEATURES

Active transient suppression

Undervoltage lockout

- -55°C to +125°C operation
- 16 to 40 VDC input
- Up to 60 dB attenuation at 500 kHz.
- Inhibit function
- Compliant to MIL-STD-461A-F



MODEL	
FM-704A	40 WATT

DESCRIPTION

The Interpoint™ FM-704A™ EMI Filter and Transient Suppression Module combines EMI filtering and transient protection to handle the demanding requirements of military, aerospace and industrial applications. As an EMI filter the FM-704A filter reduces the reflected ripple current from DC/DC switching converters. As a protection module, it suppresses input transients on the power bus to protect the converter and other downstream components.

MIL-STD NOISE MANAGEMENT

When used in conjunction with Interpoint converters, the FM-704A EMI filter reduces reflected input ripple current by a minimum of 60 dB at 500 kHz and 55 dB at 1 MHz (see Electrical Characteristics table on page 5 and Figures on page 6). This attenuation gives the converter/filter combination performance exceeding MIL-STD-461C's CE03 test. Although the FM-704A filter effectively attenuates the ripple generated by switching converters, it will not suppress RF applied to its input terminals.

TEMPERATURE OPERATION

FM-704A filters are rated to operate from -55°C to +125°C baseplate temperature. To meet MIL-STD-1275A and MIL-STD-704A requirements, derate output power linearly from 40 watts at 105°C to 20 watts at 125°C. See Figure 9.

PROTECTION

To provide protection for itself and converters, the FM-704A filter blocks transients as required by the following standards:

MIL-STD-704A	Panavia SP-P-90001
MIL-STD-461A through F	British Standard BS3G100
MIL-STD-1275	Civil Aircraft D0160B

Refer to the Electrical Characteristics table on page 5 for more information.

Reverse polarity spikes of up to 100 V will not damage the filter, however the spikes will not be blocked by the filter.

INTERNAL POWER DISSIPATION

To keep internal power dissipation to safe operating levels, the input current should never exceed 2.5 amps at 16 Vin or 1.0 amp at 40 Vin. When the FM-704A filter is used with PWM (Pulse Width Modulated) converters, Iline will vary as Power / Vline and 2.5 amps maximum at 16 Vin will reduce to approximately 1 amp maximum at 40 Vin. The maximum value allowed may be less than 1 amp as determined by line transients and the safe operating area of Figure 9.

Figure 9 illustrates the maximum allowed internal dissipation for the FM-704A filter. To calculate watts dissipated, subtract 40 volts from the transient (VT) to determine the maximum voltage across the filter and multiply the result by the current (the filter's output power, Pout divided by 40):

$$W = (VT - 40) \times Pout / 40$$

For example, with 20 watts output and a transient of 400 volts:

$$W = (400 - 40) \times 20 / 40 = 180$$

The curve of Figure 9 shows that 180 W can be dissipated for up to 4 milliseconds.

FEATURES

The inhibit function allows the FM-704A filter to be used as a high-side switch. When the inhibit terminal (pin 6) is left open or pulled high, the FM-704A filter is enabled. When the terminal is grounded, the filter shuts off output power.

A soft start function helps reduce inrush current and start-up overshoot when the filter is initially powered or when it is released from the inhibit mode.

An undervoltage lockout feature shuts off output power when input voltage falls below a specified level. Refer to Figure 8 for more information.

LAYOUT REQUIREMENTS

To minimize EMI, common mode noise, the case of the filter must be connected to the case of the converter through a low impedance connection.

FM-704A EMI Input Filter and Transient Suppression Module

28 VOLT INPUT – 40 WATT

OPERATING CONDITIONS AND CHARACTERISTICS

Input Voltage Range

- 16 to 40 VDC continuous for 40 W load

Lead Soldering Temperature (10 sec per pin)

- 300°C

Storage Temperature Range (Case)

- -65°C to +150°C

Case Operating Temperature (T_C)

- -55°C to +125°C full power

Derating Output Power/Current

- Linearly from 40 W at 105°C to 20 W at 125°C to meet MIL-STD-1275A (AT) and MIL-STD-704A

Capacitance

- 0.017 μF max, any pin to case

Undervoltage lockout

- 7 VDC min, 15 VDC max

Isolation ($T_C = 25^\circ\text{C}$)

- 100 megohm minimum at 500 V
- Any pin to case, except case pin

INHIBIT

- Active low (output disabled)
 - Active low 0.8 V max
 - Inhibit pin will source 0.6 mA max.
- Active high (output enabled)
 - Open collector
 - Open pin voltage 5.5 V max.

MECHANICAL AND ENVIRONMENTAL

Size (maximum)

- 2.910 x 1.125 x 0.400 inches (73.91 x 28.58 x 10.16 mm)
- See case K1 for dimensions.

Weight (maximum)

- 40 grams typical

Screening

- Standard, ES, or 883 (Class H). See Screening Tables 1 and 2 for more information.

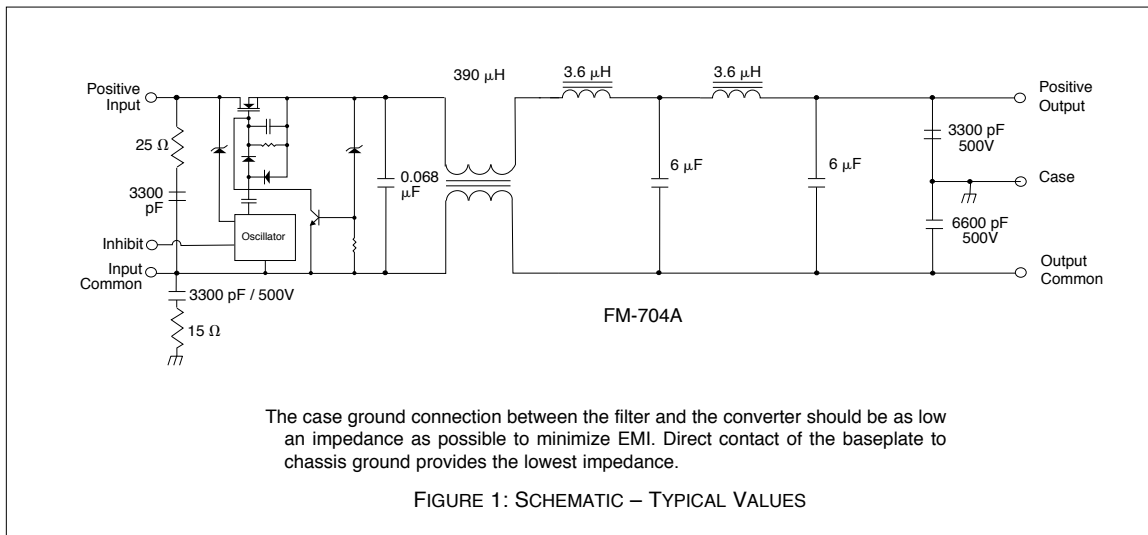

FM-704A EMI Input Filter and Transient Suppression Module

28 VOLT INPUT – 40 WATT

PIN OUT	
Pin	Designation
1	Positive Input
2	Positive Output
3	Case Ground
4	Output Common
5	Input Common
6	Inhibit

PINS NOT IN USE	
Inhibit	Leave unconnected

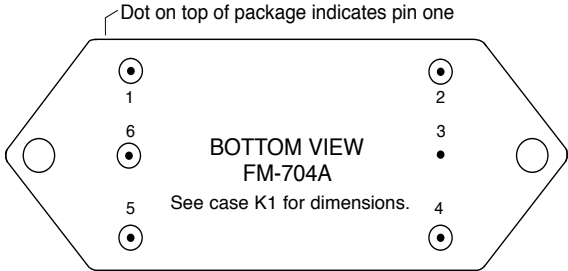
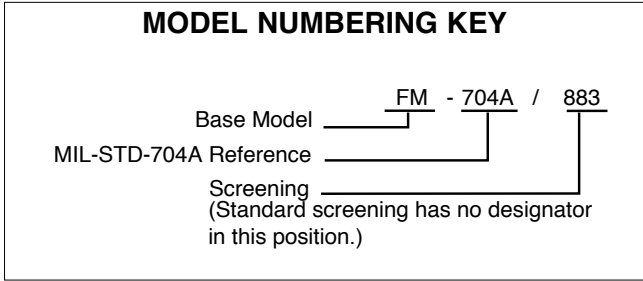

FIGURE 2: PIN OUT

FM-704A EMI Input Filter and Transient Suppression Module

28 VOLT INPUT – 40 WATT



DLA NUMBERS	
DLA DRAWING (5915)	FM-704A SIMILAR PART
94028-01HXC	FM-704A/883
For exact specifications for a DLA product, refer to the DLA drawing. DLA drawings can be downloaded from: http://www.landandmaritime.dla.mil/Programs/MilSpec/default.aspx	

MODEL NUMBER OPTIONS ¹		
TO DETERMINE THE MODEL NUMBER		
ENTER ONE OPTION FROM EACH CATEGORY		
IN THE FORM BELOW.		
CATEGORY	Base Model and Input Voltage	Screening ²
OPTIONS	FM-704A	Standard (leave blank) ES 883 (CLASS H)
FILL IN FOR MODEL #	FM-704A /	_____
Notes: 1. See Model Numbering Key above for an example of a model number. 2. Screening: For standard screening leave the screening option blank. For other screening options, insert the desired screening level. For more information see Screening Table 1.		

FM-704A EMI Input Filter and Transient Suppression Module

28 VOLT INPUT – 40 WATT

Electrical Characteristics: -55 to +125°C T_C, nominal V_{in}, unless otherwise specified.

PARAMETER	CONDITIONS	FM-704A			UNITS	
		MIN	TYP	MAX		
INPUT VOLTAGE	NO LOAD	0	28	40	VDC	
	40 W LOAD	16 ¹	28	40 ¹		
	UNDERVOLTAGE LOCKOUT	7	–	15		
INPUT CURRENT	16 V _{IN} ¹	–	–	2.5	A	
	40 V _{IN} ¹	–	–	1.0		
	NO LOAD	–	–	5	mA	
	INHIBITED	–	–	2		
INPUT SURGE	40 W, 100 V, 0.5 Ω Z _S , 60 ms ²	40	–	50	V _{OUT}	
INPUT SPIKE	40 W, 400 V, 0.5 Ω Z _S , 5 ms ³	–	–	50	V _{OUT}	
	40 W, 600 V, 50 Ω Z _S , 10 ms ^{1, 4}	–	–	50		
DIFFERENTIAL MODE NOISE REJECTION	500 kHz	60	–	–	dB	
	1 MHz	55	–	–		
DC RESISTANCE (R _{DC}) ¹	T _C = 25°C	–	–	0.45	ohms	
OUTPUT VOLTAGE	STEADY STATE	V _{OUT} = V _{IN} - I _{IN} (R _{DC})			VDC	
	INHIBITED	–	–	1		
OUTPUT CURRENT ¹	16 V _{IN}	–	–	2.5	A	
	40 V _{IN}	–	–	1.0		
INTERNAL POWER DISSIPATION ¹	PEAK	T _C = 105°C	–	–	W	
		T _C = 125°C	–	–		
	CONTINUOUS (> SEC)	T _C = 105°C	–	–		30
		T _C = 125°C	–	–		15
CAPACITANCE	ANY PIN TO CASE, T _C = 25°C	8.58		16.5	nF	

Notes

1. **Guaranteed by design, not tested.**

2. Meets MIL-STD-1275A (AT) Surge and Figure 8 and 9 of MIL-STD-704A. For these standards derate output power linearly from 40 W at 105°C to 20 W at 125°C.

3. Meets Panavia SP-P-90001, British Standard BS3G100 and Civil Aircraft D0160 Standards.

4. Meets MIL-STD-461C 1.2 CS06 limits.

FM-704A EMI Input Filter and Transient Suppression Module

28 VOLT INPUT – 40 WATT

Typical Performance Curves: 25°C T_C, nominal V_{in}, unless otherwise specified.

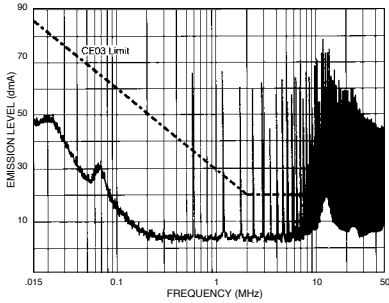

MHF+ Converter without Filter

FIGURE 3

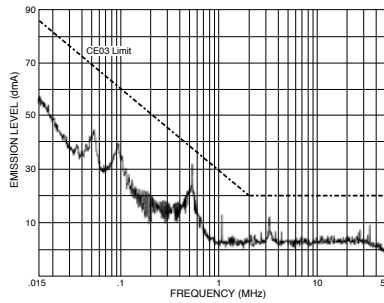

MHF+ Converter with FM-704A Filter

FIGURE 4

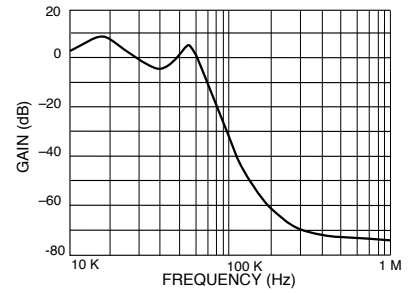

Differential Mode Response

FIGURE 5

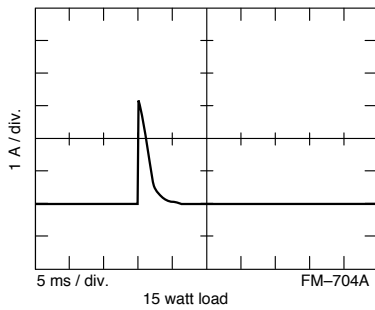

Inrush Current

FIGURE 6

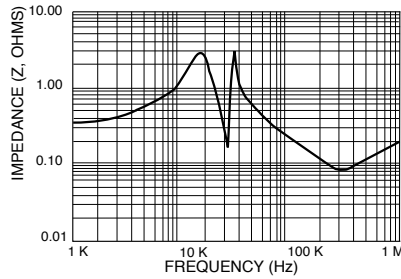

Typical Output Impedance (Z)
With Input Shorted

FIGURE 7

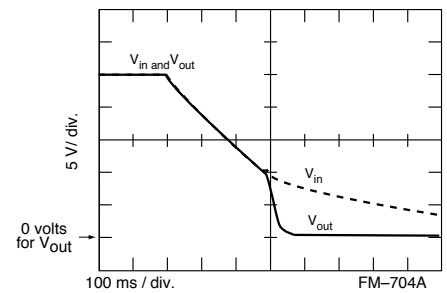

Undervoltage Lockout

FIGURE 8

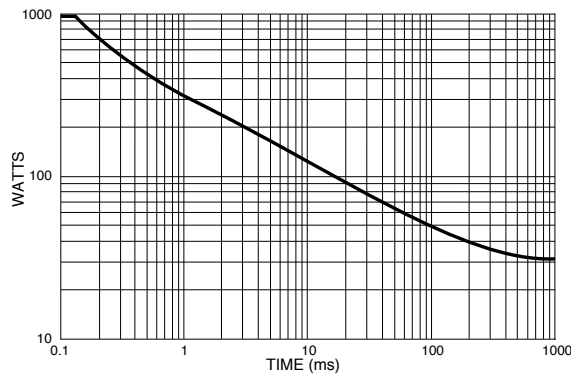

Derate power linearly to 50% at 125°C. Operation below this curve ensures a maximum junction temperature rise of 40°C or less.

Maximum Allowed Internal Power Dissipation
105°C case temperature

FIGURE 9

FM-704A EMI Input Filter and Transient Suppression Module Cases

28 VOLT INPUT – 40 WATT

BOTTOM VIEW CASE K1

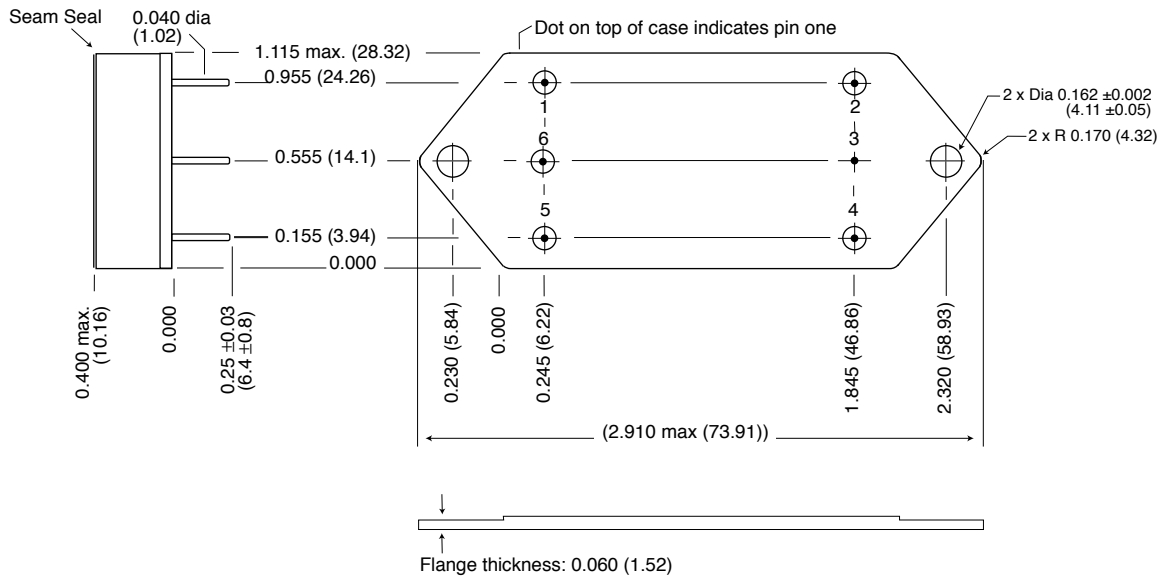

Case dimensions in inches (mm)

Tolerance ± 0.005 (0.13) for three decimal places
 ± 0.01 (0.3) for two decimal places
 unless otherwise specified

CAUTION

Heat from reflow or wave soldering may damage the device. Solder pins individually with heat application not exceeding 300°C for 10 seconds per pin.

Materials

Header Cold Rolled Steel/Nickel/Gold
 Cover Kovar/Nickel
 Pins #52 alloy/Gold ceramic seal.
 Seal Hole: 0.120 ±0.002 (3.04 ±0.05)

Case K1 FM704A, Rev F, 20100419
 Please refer to the numerical dimensions for accuracy.

FIGURE 10: CASE K1

FM-704A EMI Input Filter and Transient Suppression Module

28 VOLT INPUT – 40 WATT

STANDARD AND /ES (NON-QML) AND /883 (CLASS H, QML) MIL-PRF-38534 ELEMENT EVALUATION

COMPONENT-LEVEL TEST PERFORMED	NON-QML	QML	
	STANDARD AND /ES	CLASS H /883	
	M/S ²	M/S ²	P ³
Element Electrical	■	■	■
Visual		■	■
Internal Visual		■	
Final Electrical		■	■
Wire Bond Evaluation		■	■

Notes:

1. Non-QML products may not meet all of the requirements of MIL-PRF-38534.
2. M/S = Active components (Microcircuit and Semiconductor Die)
3. P = Passive components, Class H element evaluation. Not applicable to Standard and /ES element evaluation.

SCREENING TABLE 1: ELEMENT EVALUATION

FM-704A EMI Input Filter and Transient Suppression Module

28 VOLT INPUT – 40 WATT

STANDARD AND /ES (NON-QML) AND /883 (CLASS H, QML) MIL-PRF-38534 ENVIRONMENTAL SCREENING

TEST PERFORMED	NON-QML ¹		QML
	STANDARD	/ES	/883
Pre-cap Inspection, Method 2017, 2032	■	■	■
Temperature Cycle (10 times)			
Method 1010, Cond. C, -65°C to +150°C, ambient			■
Method 1010, Cond. B, -55°C to +125°C, ambient		■	
Constant Acceleration			
Method 2001, 3000 g			■
Method 2001, 500 g		■	
Burn-in Method 1015, +125°C case, typical ²			
96 hours		■	
160 hours			■
Final Electrical Test, MIL-PRF-38534, Group A,			
Subgroups 1 through 6, -55°C, +25°C, +125°C case			■
Subgroups 1 and 4, +25°C case	■	■	■
Hermeticity Test			
Gross Leak, Method 1014, Cond. C		■	■
Fine Leak, Method 1014, Cond. A		■	■
Gross Leak, Dip	■		
Final visual inspection, Method 2009	■	■	■

Test methods are referenced to MIL-STD-883 as determined by MIL-PRF-38534.

Notes:

1. Standard and /ES, non-QML products, may not meet all of the requirements of MIL-PRF-38534.
2. Burn-in temperature designed to bring the case temperature to +125°C minimum. Burn-in is a powered test.

SCREENING TABLE 2: ENVIRONMENTAL SCREENING