

# MOR Single and Dual DC/DC Converters

## 28 VOLT INPUT – 120 WATT

### FEATURES

**Parallel operation with current share, up to 5 units (540 watts)**

**Output flexibility, trim of 60% to 110%**

- Operating temperature -55° to +125°C
- Input voltage 16 to 40 VDC
- Transient protection 50 V for 120 ms
- Fully isolated, magnetic feedback
- Fixed high frequency switching
- Remote sense on single output models
- Inhibit function
- Sync In and Sync Out
- Indefinite short circuit protection
- High power density with up to 87% efficiency



### MODELS VDC OUTPUT

SINGLES	DUALS
3.3	±3.3
5	±5
6.3	±6.3
9.5	±9.5
12	±12
15	±15

### DESCRIPTION

With up to 120 watts of output power, the MOR Series™ of DC/DC converters operates from a standard 28 volt bus and offers a wide input range of 16 to 40 VDC. Full operation over the military temperature range, -55°C to +125°C, makes the MOR Series an ideal choice for military, aerospace, space, and other high reliability applications. In compliance with MIL-STD-704D, the converters will withstand transients of up to 50 volts for up to 120 milliseconds. Use Interpoint's FMCE-1528 EMI filter to meet the requirements of MIL-STD-461C CE03 and CS01 and/or MIL-STD-461D, E and F CE102 and CS101 levels of conducted emissions.

The converters are offered with standard screening, "ES" screening, or fully compliant to "883" MIL-PRF-38534 Class H screening. Standard microcircuit drawings (SMD) are available.

The MOR Series converters incorporate a single-ended forward topology which uses a constant frequency Pulse Width Modulator (PWM) current mode control design and switches at 550 kHz, nominal.

### SHORT CIRCUIT PROTECTION

The converters also provide short circuit protection by restricting the current to 125% of the full load output current, typical.

### INHIBIT FUNCTION

All models offer two inhibits, one referenced to input common and one referenced sense return (single output models) or to output common (dual output models). A remote sense function is available on single output models.

### TRIM FUNCTION

Using the trim function, the MOR Series can provide any output from 2 to 33 VDC. For example, trimming the two 15 volt outputs of the 15 dual (MOR2815D) to 14 volts, and then stacking the outputs will provide a 28 volt output.

### OUTPUT VOLTAGE OPTIONS

The MOR Series converters are capable of providing other output voltage options in addition to those characterized on this datasheet. Contact your sales representative to discuss other output voltage options, [www.interpoint.com/contacts](http://www.interpoint.com/contacts).

### US PATENTS

Interpoint converters may use one or more of the following US patents 5,521,807, 5,694,303, and 5,631,822.

# MOR Single and Dual DC/DC Converters

## 28 VOLT INPUT – 120 WATT

### HOW TO USE THE FUNCTIONS

#### INPUT VOLTAGE

Steady state voltage range is 16 to 40 VDC. Transient range is 40 to 50 V for a maximum of 120 msec. All models include a soft-start function to prevent large current draw and minimize overshoot.

#### EMI INPUT FILTERS

Internal 500 volt capacitors are connected between the case and input common and between the case and output common.

Use Interpoint's FMCE-1528 EMI filter to meet the requirements of MIL-STD-461C CE03 and CS01 and/or MIL-STD-461D, E and F CE102 and CS101 levels of conducted emissions. When using an external input filter it is important that the case of the filter and the case of the converter be connected through as low as an impedance as possible. Direct connection of the baseplates to chassis ground is the best connection. If connected by a single trace, the trace should be as wide as it is long. See Figure 1.

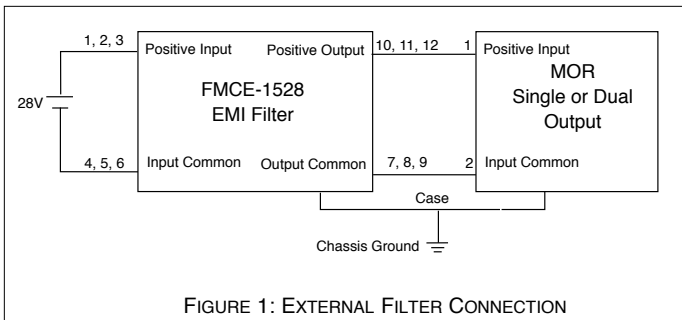

FIGURE 1: EXTERNAL FILTER CONNECTION

#### TRIM

Both single and dual output models include a trim function. Output voltage can be trimmed from 60% up to 110% of nominal V out . When trimming up, do not exceed the maximum output power. When trimming down, do not exceed the maximum output current. See Figure 2.

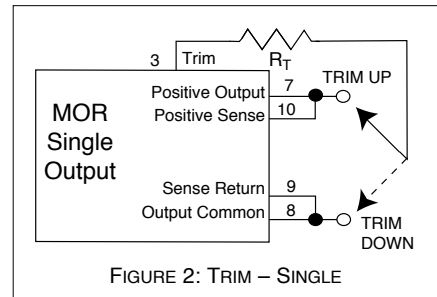

FIGURE 2: TRIM – SINGLE

On dual models the positive output is regulated and the negative output is transformer coupled (cross-regulated) to the positive output. When trimming the duals, both output voltages will be adjusted equally. See Figure 3.

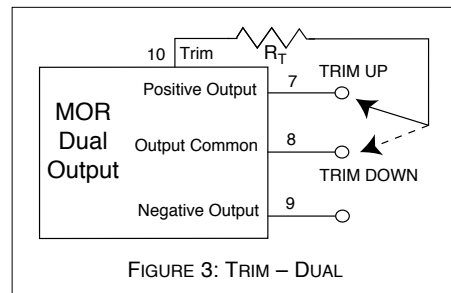

FIGURE 3: TRIM – DUAL

### TRIM FORMULAS

#### Trim Up:

$$a = \frac{V_o}{V_o \text{ nominal}}, 1.0 \leq a \leq 1.1$$

$$R_T \text{ (k}\Omega\text{)} = \frac{\left(\frac{V_o}{2.5} - 1\right) \cdot 20}{(a - 1)} - 50$$

Example:

$$V_o \text{ nominal} = 5.0, V_o = 5.25, a = 1.05, R_T = 390 \text{ k}\Omega$$

#### Trim Down:

$$a = \frac{V_o}{V_o \text{ nominal}}, 0.6 \leq a \leq 1.0$$

$$R_T \text{ (k}\Omega\text{)} = \frac{50 \cdot a - 30}{1 - a}$$

$$\text{Example: } V_o \text{ nominal} = 5.0, V_o = 4.5, a = 0.9, R_T = 150 \text{ k}\Omega$$

# MOR Single and Dual DC/DC Converters

## 28 VOLT INPUT – 120 WATT

### INHIBIT 1 AND 2

Two inhibit terminals disable switching, resulting in no output and very low quiescent input current. The two inhibit pins allow access to an inhibit function on either side of the isolation barrier to help maintain isolation.

An open collector is required for interfacing with both of the inhibit pins. Applying an active low to either inhibit pin will inhibit the converter. Leaving the pins open will enable the converter. Inhibit 1 is referenced to Input Common. Inhibit 2 is referenced to Sense Return for single output models and to Output Common for dual output models.

The open circuit voltage (unit enabled) for Inhibit 1 is 13 V and for Inhibit 2 it is up to 8 V. Leave the Inhibit pins unconnected if not used. The required active low voltage level is 0.8 V maximum for Inhibit 1 and 0.2 V maximum for Inhibit 2. See Figures 4 and 5.

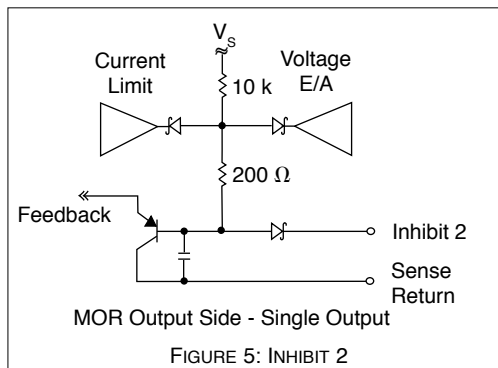
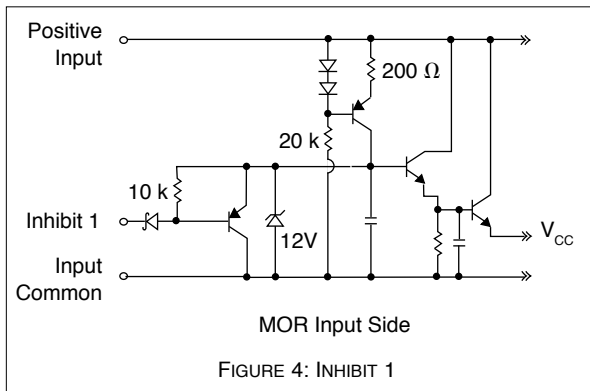

### UNDERVOLTAGE LOCKOUT

Undervoltage lockout prevents the units from operating below approximately 15.5 VDC input voltage to keep system current levels smooth, especially during initialization or re-start operations.

### SYNC IN AND SYNC OUT

The MOR converters can be synchronized to the system clock by applying an active high sync signal to the Sync In pin. Sync Out can be used to synchronize other components to the MOR converter's switching frequency.

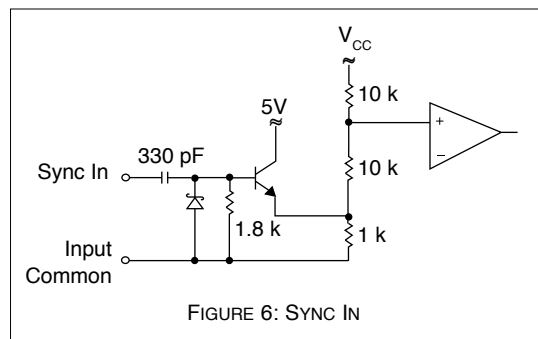

The frequency range for external synchronization is 525 to 625 kHz. The requirements for an external signal are 15% to 50% duty cycle,  $0 \leq L \leq 0.8$  V and  $4.5 \leq H \leq 9$  V. Both Sync In and Sync Out are referenced to input common. Sync In should be connected to input common if not used. See Figures 6 and 7.

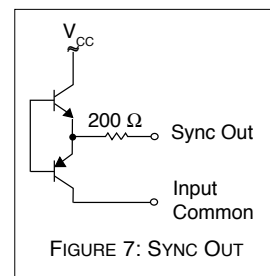

### POSITIVE OUTPUT, NEGATIVE OUTPUT AND OUTPUT COMMON

Output current is typically limited to 125% of maximum specified current under short circuit or load fault conditions.

Single output models operate from no load to full load. Dual output models with balanced loads operate from no load to full load. For dual models with unbalanced loads, at least 10% of the total output power must be drawn from the positive output at all times, however, the negative output does not require a minimum load. See note 4, cross regulation, under the Electrical Characteristics Tables.

# MOR Single and Dual DC/DC Converters

## 28 VOLT INPUT – 120 WATT

### PARALLELING (SHARE PIN)

By using the Share pin, up to five single or dual converters may be paralleled for a total output power of up to 540 watts, depending on model. To calculate available power, multiply the number of converters (up to five) by their maximum output power. Multiply the result by 90% for total available power. See Figure 8 for the internal circuit. The converters will share within 10% of each other at 25% to 90% rated power. MOR converters feature true n+1 redundancy for reliability in critical applications. See Figure 9 for the proper connections.

All Positive Outputs and Positive Senses should be connected to a common point. All Negative Outputs and Sense Returns should be connected to a common point. The Share pin is referenced to Sense Return. Leave the share pin floating (unconnected) if not used. Also see Figure 9.

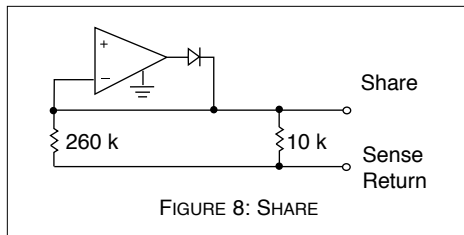

FIGURE 8: SHARE

### POSITIVE SENSE, SENSE RETURN

A special remote sensing feature maintains the desired output voltage at the load. See Figure 9. When this feature is not used, connect the sense lines to their respective output terminals. See Figure 10. Remote sensing is available on single output models only. Do not exceed 110% of  $V_{out}$  and do not exceed maximum output power.

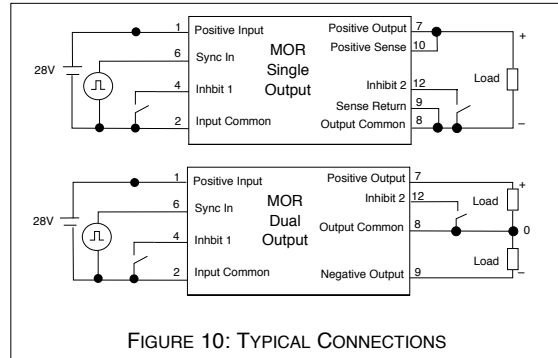

FIGURE 10: TYPICAL CONNECTIONS

**INCREASE OUTPUT VOLTAGE BY STACKING OUTPUTS**  
Outputs may be stacked to increase the output voltage using a dual model.

Dual outputs may be stacked to double the output voltage. See Figure 11.

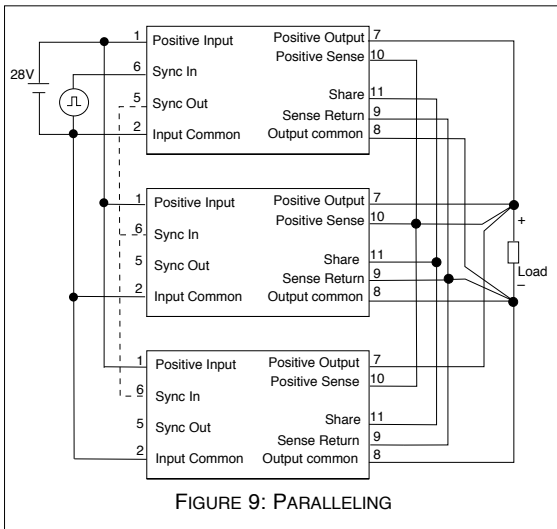

FIGURE 9: PARALLELING

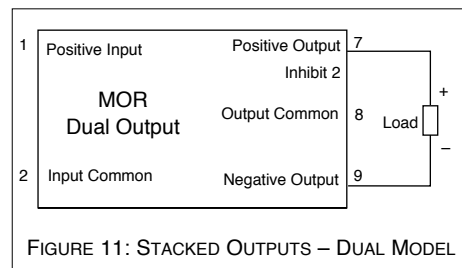

FIGURE 11: STACKED OUTPUTS – DUAL MODEL

# MOR Single and Dual DC/DC Converters

28 VOLT INPUT – 120 WATT

## BLOCK DIAGRAM

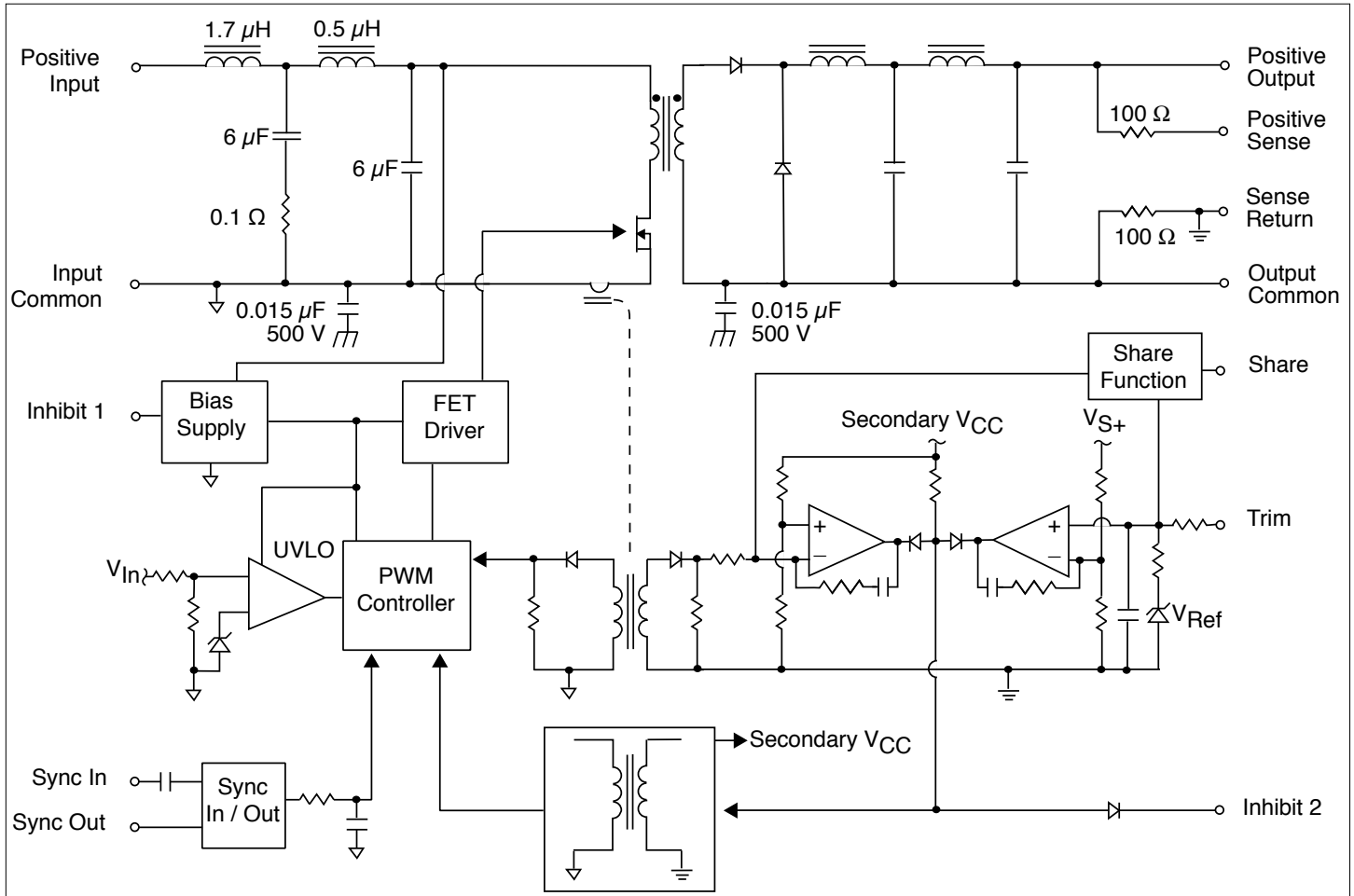

FIGURE 12: MOR SINGLE OUTPUT BLOCK DIAGRAM

# MOR Single and Dual DC/DC Converters

## 28 VOLT INPUT – 120 WATT

### OPERATING CONDITIONS AND CHARACTERISTICS

#### Input Voltage Range

- 16 to 40 VDC continuous
- 50 V for 120 ms transient

#### Output Power

- 66 to 120 W, depending on model

#### Lead Soldering Temperature (10 sec per lead)

- 300°C

#### Storage Temperature Range (T<sub>C</sub>)

- -65°C to +150°C

#### Case Operating Temperature (T<sub>C</sub>)

- -55°C to +125°C full power
- -55°C to +135°C absolute

#### Derating Output Power/Current

- Linearly from 100% at 125°C to 0% at 135°C

#### Output Voltage Temperature Coefficient

- 100 ppm/°C typ

#### Input to Output Capacitance

- 150 pF typical

#### Current Limit

- 125% of full load typ

#### Isolation

- 100 megohm min at 500 V

#### Audio Rejection

- 40 dB typ

#### Conversion Frequency

- Free run mode, 25°C, 550 kHz typ
  - 480 kHz. min, 580 kHz max

#### Undervoltage Lockout

- 15.5 V input typ

### SYNC AND INHIBIT

#### Sync

- Sync In
  - Input frequency 525 to 625 kHz
  - Active low 0.8 V max, duty cycle 15% to 50%
  - Active high 4.5 V min, 9 V max
  - Referenced to input common
- Sync Out - Referenced to input common

#### Inhibit (INH1, INH2)

- Active low (output disabled)
  - Inhibit 1 (INH1)
    - Referenced to input common
    - 0.8 V max.
    - Inhibit pin current 1 mA max
  - Inhibit 2 (INH2)
    - Single output models are referenced to Sense Return
    - Dual output models are referenced to Output Common
    - 0.2 V max
    - Inhibit pin current 1 mA max
- Active high (output enabled) open collector
  - Open pin voltage:
    - Inhibit 1 (INH1) = 13 V typ.
    - Inhibit 2 (INH2) = up to 8 V

### MECHANICAL AND ENVIRONMENTAL

#### Size (maximum)

- 3.005 x 1.505 x 0.400 inches (76.33 x 38.23 x 10.16 mm)
- Available in a variety of packages. See cases U2, V, W, Y, and Z for dimensions.

#### Weight (maximum)

- 110 grams

#### Screening

- Standard, ES, or 883 (Class H, QML) available. See Screening Tables 1 and 2 for more information.

# MOR Single and Dual DC/DC Converters

## 28 VOLT INPUT – 120 WATT

PIN OUT		
Pin	Single Output	Dual Output
1	Positive Input	Positive Input
2	Input Common	Input Common
3	Trim	Case
4	Inhibit 1 (INH1)	Inhibit 1 (INH1)
5	Sync Out	Sync Out
6	Sync In	Sync In
7	Positive Output	Positive Output
8	Output Common	Output Common
9	Sense Return	Negative Output
10	Positive Sense	Trim
11	Share	Share
12	Inhibit 2 (INH2)	Inhibit 2 (INH2)

PINS NOT IN USE	
Case	User's discretion
Inhibit (INH1, INH2)	Leave unconnected
Sense Line	Must be connected to the appropriate outputs
Sync In	Connect to input common
Sync Out	Leave unconnected
Share	Leave unconnected
Trim	Leave unconnected

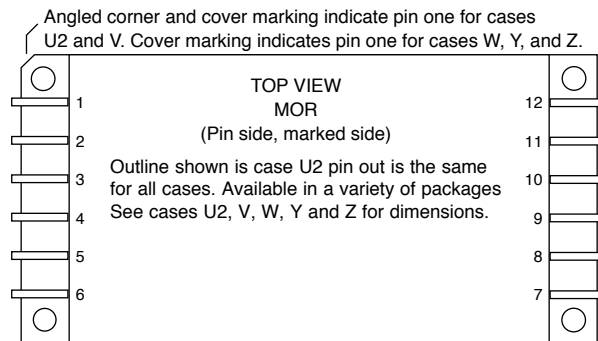
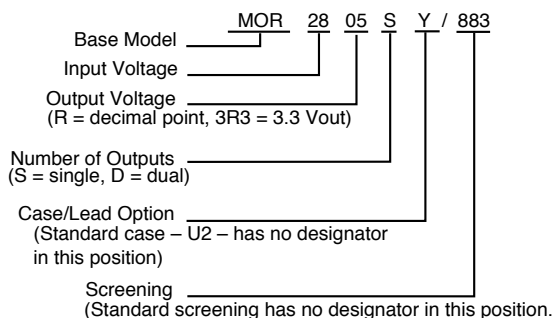

FIGURE 13: PIN OUT TOP VIEW

# MOR Single and Dual DC/DC Converters

## 28 VOLT INPUT – 120 WATT

### MODEL NUMBERING KEY



### SMD NUMBERS

STANDARD MICROCIRCUIT DRAWING (SMD)	MOR SIMILAR PART
5962-9954401HXC	MOR283R3S/883
5962-9954801HXC	MOR2805S/883
5962-9954501HXC	MOR286R3S/883
5962-9954601HXC	MOR289R5S/883
5962-9954901HXC	MOR2812S/883
5962-9955001HXC	MOR2815S/883
5962-9956401HXC	MOR283R3D/883
5962-9956101HXC	MOR2805D/883
5962-9956501HXC	MOR286R3D/883
5962-9956601HXC	MOR289R5D/883
5962-9956201HXC	MOR2812D/883
5962-9956301HXC	MOR2815D/883

The models listed have the standard U2 case option. In the DSCC number "X" is the equivalent of the standard U2 case.

For exact specifications for an SMD product, refer to the SMD drawing. SMDs can be downloaded from: <http://www.dscclia.mil/programs/smcr>

### Cases: SMD and Similar Part Number

STANDARD MICROCIRCUIT DRAWING (SMD)	MOR SIMILAR PART
X	STANDARD CASE (U2)
U	V
T	W
Y	Y
Z	Z

### MODEL SELECTION

ON THE LINES BELOW, ENTER ONE SELECTION FROM EACH CATEGORY TO DETERMINE THE MODEL NUMBER.

CATEGORY	MOR28 Base Model and Input Voltage	_____ / _____ Output Voltage <sup>1</sup>	_____ Number of Outputs <sup>2</sup>	_____ Case/Lead Options <sup>3</sup>	/ _____ Screening <sup>4</sup>
SELECTION	MOR28 is the only available option	<b>3R3</b> <b>05</b> <b>6R3</b> <b>9R5</b> <b>12</b> <b>15</b>	<b>S</b> <b>D</b>	(U2 leave blank) <b>V</b> <b>W</b> <b>Y</b> <b>Z</b>	(STANDARD leave blank) <b>ES</b> <b>883</b>

Notes:

- Output Voltage: An R indicates a decimal point. 3R3 is 3.3 volts out.
- Number of Outputs: S is a single output and D is a dual output
- Case Options: For the standard case (case U2) leave the case option blank. For other case options, insert the letter that corresponds to the desired case.
- Screening: For standard screening leave the screening option blank. For other screening options, insert the desired screening level. For more information see Screening Tables 1 and 2.



# MOR Single and Dual DC/DC Converters

## 28 VOLT INPUT – 120 WATT

Electrical Characteristics: -55 to +125°C T<sub>C</sub>, 28 VDC Vin, 100% load, free run, unless otherwise specified.

SINGLE OUTPUT MODELS		MOR283R3S			MOR2805S			MOR286R3S			UNITS
PARAMETER	CONDITIONS	MIN	TYP	MAX	MIN	TYP	MAX	MIN	TYP	MAX	
OUTPUT VOLTAGE		3.22	3.30	3.38	4.87	5.00	5.25	6.17	6.30	6.43	VDC
OUTPUT CURRENT	V <sub>IN</sub> = 16 TO 40 VDC	0	—	20	0	—	20	0	—	16	A
OUTPUT POWER	V <sub>IN</sub> = 16 TO 40 VDC	0	—	66	0	—	100	0	—	100	W
OUTPUT RIPPLE	10 kHz - 20 MHz	—	30	80	—	30	80	—	75	100	mV p-p
	10 kHz - 2 MHz	—	20	50	—	20	50	—	50	60	
LINE REGULATION	V <sub>IN</sub> = 16 TO 40 VDC	—	0	20	—	0	20	—	0	20	mV
LOAD REGULATION	NO LOAD TO FULL	—	0	30	—	0	30	—	0	30	mV
INPUT VOLTAGE	CONTINUOUS	16	28	40	16	28	40	16	28	40	VDC
	TRANSIENT 120 msec. <sup>1</sup>	—	—	50	—	—	50	—	—	50	V
INPUT CURRENT	NO LOAD	—	70	150	—	70	150	—	70	150	mA
	INHIBITED-INH1	—	—	10	—	—	10	—	—	10	
	INHIBITED-INH2	—	—	70	—	—	70	—	—	70	
INPUT RIPPLE CURRENT	10 kHz - 20 MHz	—	40	90	—	50	130	—	50	130	mA p-p
EFFICIENCY		74	78	—	77	81	—	80	83	—	%
LOAD FAULT	POWER DISSIPATION OVERLOAD <sup>1</sup>	—	27	—	—	30	—	—	30	—	W
	SHORT CIRCUIT <sup>2</sup>	—	—	22	—	—	27	—	—	24	
	RECOVERY <sup>1</sup>	—	—	10	—	—	10	—	—	10	ms
STEP LOAD RESPONSE	50% - 100% - 50%										
	TRANSIENT	—	—	250	—	—	250	—	—	500	mV pk
	RECOVERY <sup>3</sup>	—	—	200	—	—	200	—	—	300	μs
STEP LINE RESPONSE	16 - 40 - 16 VDC TRANSIENT <sup>1, 4</sup>	—	—	400	—	—	400	—	—	500	mV pk
	RECOVERY <sup>1, 3</sup>	—	—	300	—	—	300	—	—	300	μs
START-UP <sup>5</sup>	DELAY	—	—	10	—	—	10	—	—	10	ms
	OVERSHOOT <sup>1</sup>	—	0	25	—	0	50	—	0	50	mV pk
CAPACITIVE LOAD <sup>1</sup>	NO EFFECT ON DC PERFORMANCE	—	—	1000	—	—	1000	—	—	1000	μF

## Notes:

1. Guaranteed by design, not tested.

2. Short circuit is measured with a 10 m ohm (±10%) resistive load.

3. Time to settle to within 1% of V<sub>out</sub>.

4. Transition time > 10 μs

5. Tested on release from inhibit.

# MOR Single and Dual DC/DC Converters

## 28 VOLT INPUT – 120 WATT

Electrical Characteristics: -55 to +125°C T<sub>C</sub>, 28 VDC Vin, 100% load, free run, unless otherwise specified.

SINGLE OUTPUT MODELS		MOR289R5S			MOR2812S			MOR2815S			UNITS
PARAMETER	CONDITIONS	MIN	TYP	MAX	MIN	TYP	MAX	MIN	TYP	MAX	
OUTPUT VOLTAGE		9.31	9.50	9.69	11.76	12.00	12.24	14.70	15.00	15.30	VDC
OUTPUT CURRENT	V <sub>IN</sub> = 16 TO 40 VDC	0	—	11	0	—	9.2	0	—	8	A
OUTPUT POWER	V <sub>IN</sub> = 16 TO 40 VDC	0	—	105	—	—	110	—	—	120	W
OUTPUT RIPPLE	10 kHz - 20 MHz	—	75	120	—	75	120	—	75	150	mV p-p
	10 kHz - 2 MHz	—	50	80	—	50	100	—	50	120	
LINE REGULATION	V <sub>IN</sub> = 16 TO 40 VDC	—	0	40	—	0	20	—	0	40	mV
LOAD REGULATION	NO LOAD TO FULL	—	0	95	—	0	100	—	0	100	mV
INPUT VOLTAGE	CONTINUOUS	16	28	40	16	28	40	16	28	40	VDC
	TRANSIENT 120 ms <sup>1</sup>	—	—	50	—	—	50	—	—	50	V
INPUT CURRENT	NO LOAD	—	70	150	—	70	150	—	70	150	mA
	INHIBITED–INH1	—	—	10	—	—	10	—	—	10	
	INHIBITED–INH2	—	—	70	—	—	70	—	—	70	
INPUT RIPPLE CURRENT	10 kHz - 20 MHz	—	50	130	—	50	130	—	50	130	mA p-p
EFFICIENCY		80	84	—	83	86	—	83	87	—	%
LOAD FAULT	POWER DISSIPATION										W
	OVERLOAD <sup>1</sup>	—	—	30	—	—	30	—	—	30	
	SHORT CIRCUIT <sup>2</sup>	—	—	24	—	—	22	—	—	20	
	RECOVERY <sup>1</sup>	—	—	10	—	—	10	—	—	10	ms
STEP LOAD RESPONSE	50% - 100% - 50%										mV pk
	TRANSIENT	—	—	500	—	—	600	—	—	600	
	RECOVERY <sup>3</sup>	—	—	300	—	—	300	—	—	300	
STEP LINE RESPONSE	16 - 40 - 16 VDC										mV pk
	TRANSIENT <sup>1, 4</sup>	—	—	500	—	—	600	—	—	600	
	RECOVERY <sup>1, 3</sup>	—	—	300	—	—	300	—	—	300	
START-UP <sup>5</sup>	DELAY	—	—	10	—	—	10	—	—	10	ms
	OVERSHOOT <sup>1</sup>	—	—	50	—	—	50	—	—	50	mV pk
CAPACITIVE LOAD <sup>1</sup>	NO EFFECT ON DC PERFORMANCE	—	—	1000	—	—	1000	—	—	1000	μF

Notes:

1. Guaranteed by design, not tested.

2. Short circuit is measured with a 10 m ohm (±10%) resistive load.

3. Time to settle to within 1% of V<sub>out</sub>.

4. Transition time > 10 μs

5. Tested on release from inhibit.

# MOR Single and Dual DC/DC Converters

## 28 VOLT INPUT – 120 WATT

Electrical Characteristics: -55°C to +125°C T<sub>C</sub>, 28 VDC Vin, 100% load, free run, unless otherwise specified.

DUAL OUTPUT MODELS		MOR283R3D			MOR2805D			MOR286R3D			UNITS
PARAMETER	CONDITIONS	MIN	TYP	MAX	MIN	TYP	MAX	MIN	TYP	MAX	
OUTPUT VOLTAGE <sup>2</sup>	+V <sub>OUT</sub>	3.20	3.30	3.40	4.85	5.00	5.15	6.17	6.30	6.43	VDC
	-V <sub>OUT</sub>	3.16	3.30	3.44	4.82	5.00	5.18	6.12	6.30	6.48	
OUTPUT CURRENT <sup>3</sup> VIN = 16 TO 40 VDC	EACH OUTPUT	—	±10	14 <sup>1</sup>	—	±10	14 <sup>1</sup>	—	±8	11.2 <sup>1</sup>	A
	TOTAL	—	—	20	—	—	20	—	—	16	
OUTPUT POWER <sup>3</sup> VIN = 16 TO 40 VDC	EACH OUTPUT	—	±33	46 <sup>1</sup>	—	±50	70 <sup>1</sup>	—	±50	70 <sup>1</sup>	W
	TOTAL	—	—	66	—	—	100	—	—	100	
OUTPUT RIPPLE ±V <sub>OUT</sub>	10 kHz - 20 MHz	—	50	80	—	50	80	—	50	100	mV p-p
	10 kHz - 2 MHz	—	35	50	—	35	50	—	30	60	
LINE REGULATION VIN = 16 TO 40 VDC	+V <sub>OUT</sub>	—	25	50	—	25	50	—	25	50	mV
	-V <sub>OUT</sub>	—	50	100	—	50	100	—	50	100	
LOAD REGULATION	+V <sub>OUT</sub>	—	25	50	—	25	50	—	25	50	mV
	-V <sub>OUT</sub>	—	50	100	—	50	150	—	50	200	
CROSS REGULATION <sup>1, 4</sup>	-V <sub>OUT</sub>	—	6	10	—	5	8	—	5	8	%
INPUT VOLTAGE	CONTINUOUS	16	28	40	16	28	40	16	28	40	VDC
	TRANSIENT 120 ms <sup>1</sup>	—	—	50	—	—	50	—	—	50	V
INPUT CURRENT	NO LOAD	—	70	160	—	70	160	—	70	160	mA
	INHIBITED-INH1	—	—	10	—	—	10	—	—	10	
	INHIBITED-INH2	—	—	70	—	—	70	—	—	70	
INPUT RIPPLE CURRENT	10 MHz - 20 MHz	—	60	90	—	60	130	—	—	130	mA p-p
EFFICIENCY		75	77	—	77	81	—	80	83	—	%
LOAD FAULT	POWER DISSIPATION										W
	OVERLOAD <sup>1</sup>	—	—	27	—	—	30	—	—	30	
	SHORT CIRCUIT <sup>5</sup>	—	—	22	—	—	27	—	—	24	
	RECOVERY <sup>1</sup>	—	—	10	—	—	10	—	—	10	ms
STEP LOAD RESPONSE ±V <sub>OUT</sub>	50% - 100% - 50%										mV pk
	TRANSIENT	—	—	250	—	—	250	—	—	500	
	RECOVERY <sup>6</sup>	—	—	300	—	—	200	—	—	300	
STEP LINE RESPONSE ±V <sub>OUT</sub>	16 - 40 - 16 VDC										mV pk
	TRANSIENT <sup>1, 7</sup>	—	—	400	—	—	400	—	—	500	
	RECOVERY <sup>1, 6</sup>	—	—	300	—	—	300	—	—	300	
START-UP <sup>8</sup>	DELAY	—	—	10	—	—	10	—	—	10	ms
	OVERSHOOT <sup>1</sup>	—	—	25	—	—	50	—	—	50	mV pk
CAPACITIVE LOAD <sup>1</sup>	NO EFFECT ON DC										μF
	PERFORMANCE	—	—	1000	—	—	1000	—	—	1000	

Notes:

1. Guaranteed by design, not tested.

2. Output voltage for dual output models is measured at half load.

3. The "Total" specification is the maximum combined current/power of both outputs.

Up to 70% of that total is available from either output provided the other output maintains a minimum of 15% of the total power used. The 15% minimum maintains regulation.

4. Effect on negative Vout from 50%/50% loads to 70%/30% or 30%/70% loads.

5. Short circuit is measured with a 10 milliohm (±10%) resistive load.

6. Time to settle to within 1% of Vout.

7. Transition time > 10 μs

8. Tested on release from inhibit.

# MOR Single and Dual DC/DC Converters

## 28 VOLT INPUT – 120 WATT

Electrical Characteristics: -55°C to +125°C T<sub>C</sub>, 28 VDC Vin, 100% load, free run, unless otherwise specified.

DUAL OUTPUT MODELS		MOR289R5D			MOR2812D			MOR2815D			UNITS
PARAMETER	CONDITIONS	MIN	TYP	MAX	MIN	TYP	MAX	MIN	TYP	MAX	
OUTPUT VOLTAGE <sup>2</sup>	+V <sub>OUT</sub>	9.31	9.50	9.69	11.76	12.00	12.24	14.70	15.00	15.30	VDC
	-V <sub>OUT</sub>	9.26	9.50	9.74	11.70	12.00	12.30	14.62	15.00	15.38	
OUTPUT CURRENT <sup>3</sup> VIN = 16 TO 40 VDC	EACH OUTPUT	—	±5.53	7.75 <sup>1</sup>	—	±4.58	6.4 <sup>1</sup>	—	±4.00	5.6 <sup>1</sup>	A
	TOTAL	—	—	11.05	—	—	9.16	—	—	8	
OUTPUT POWER <sup>3</sup> VIN = 16 TO 40 VDC	EACH OUTPUT	—	±52.5	73.5 <sup>1</sup>	—	±55	77 <sup>1</sup>	—	±60	84 <sup>1</sup>	W
	TOTAL	—	—	105	—	—	110	—	—	120	
OUTPUT RIPPLE ±V <sub>OUT</sub>	10 kHz - 20 MHz	—	75	120	—	75	120	—	75	150	mV p-p
	10 kHz - 2 MHz	—	50	80	—	50	100	—	50	120	
LINE REGULATION VIN = 16 TO 40 VDC	+V <sub>OUT</sub>	—	25	50	—	25	50	—	25	50	mV
	-V <sub>OUT</sub>	—	50	100	—	50	100	—	50	100	
LOAD REGULATION	+V <sub>OUT</sub>	—	25	50	—	25	50	—	25	50	mV
	-V <sub>OUT</sub>	—	50	200	—	50	200	—	50	200	
CROSS REGULATION <sup>1, 4</sup>	-V <sub>OUT</sub>	—	4	7	—	3	5	—	2	4	%
INPUT VOLTAGE	CONTINUOUS	16	28	40	16	28	40	16	28	40	VDC
	TRANSIENT 120 ms <sup>1</sup>	—	—	50	—	—	50	—	—	50	V
INPUT CURRENT	NO LOAD	—	70	160	—	70	160	—	70	160	mA
	INHIBITED-INH1	—	—	10	—	—	10	—	—	10	
	INHIBITED-INH2	—	—	70	—	—	70	—	—	70	
INPUT RIPPLE CURRENT	10 MHz - 20 MHz	—	—	130	—	—	130	—	—	130	mA p-p
EFFICIENCY		80	84	—	82	86	—	83	87	—	%
LOAD FAULT	POWER DISSIPATION OVERLOAD <sup>1</sup>	—	—	30	—	—	30	—	—	30	W
	SHORT CIRCUIT <sup>5</sup>	—	—	24	—	—	22	—	—	20	
	RECOVERY <sup>1</sup>	—	—	10	—	—	10	—	—	10	ms
STEP LOAD RESPONSE ±V <sub>OUT</sub>	50% - 100% - 50% TRANSIENT	—	—	500	—	—	600	—	—	600	mV pk
	RECOVERY <sup>6</sup>	—	—	300	—	—	300	—	—	300	μs
	STEP LINE RESPONSE ±V <sub>OUT</sub>	16 - 40 - 16 VDC TRANSIENT <sup>1, 7</sup>	—	—	600	—	—	600	—	—	750
START-UP <sup>8</sup>	RECOVERY <sup>1, 6</sup>	—	—	300	—	—	300	—	—	300	μs
	DELAY	—	—	10	—	—	10	—	—	10	ms
CAPACITIVE LOAD <sup>1</sup>	OVERSHOOT <sup>1</sup>	—	—	50	—	—	25	—	—	50	mV pk
	NO EFFECT ON DC PERFORMANCE	—	—	1000	—	—	1000	—	—	1000	μF

## Notes:

1. Guaranteed by design, not tested.

2. Output voltage for dual output models is measured at half load.

3. The "Total" specification is the maximum combined current/power of both outputs.

Up to 70% of that total is available from either output provided the other output maintains a minimum of 15% of the total power used. The 15% minimum maintains regulation.

4. Effect on negative Vout from 50%/50% loads to 70%/30% or 30%/70% loads.

5. Short circuit is measured with a 10 milliohm (±10%) resistive load.

6. Time to settle to within 1% of Vout.

7. Transition time > 10 μs

8. Tested on release from inhibit.

# MOR Single and Dual DC/DC Converters

## 28 VOLT INPUT – 120 WATT

Typical Performance Curves: 25°C T<sub>C</sub>, 28 VDC Vin, 100% load, free run, unless otherwise specified.

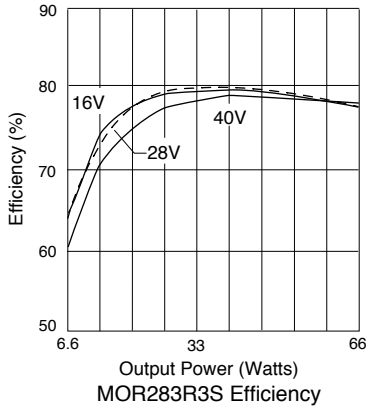

FIGURE 14

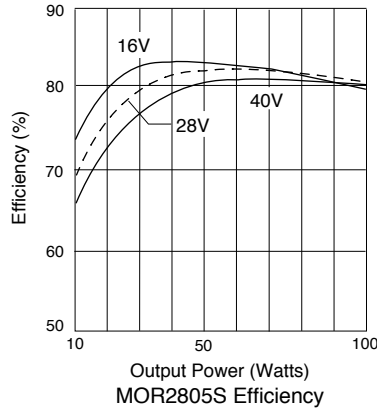

FIGURE 15

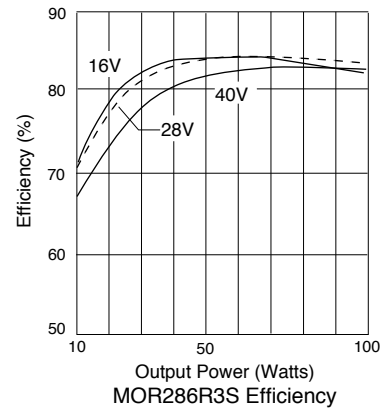

FIGURE 16

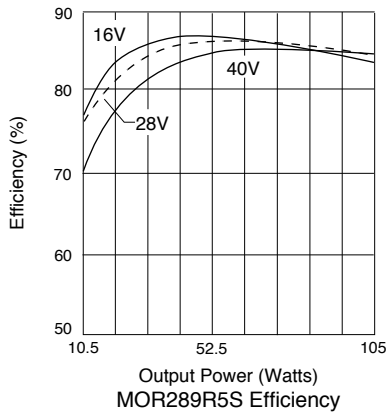

FIGURE 17

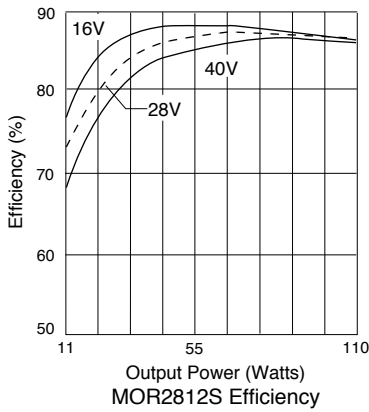

FIGURE 18

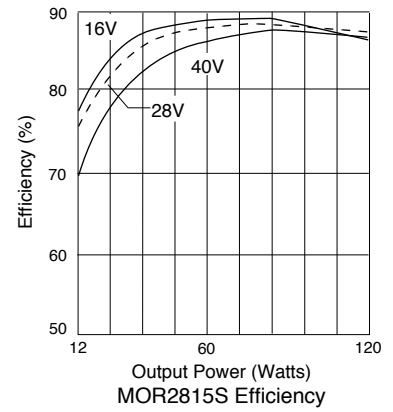

FIGURE 19

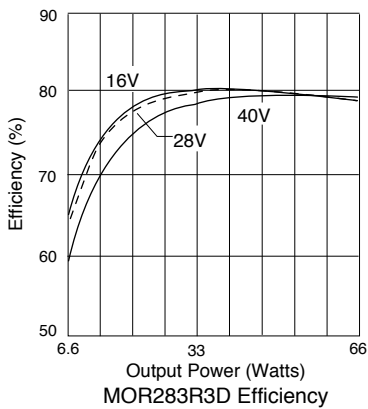

FIGURE 20

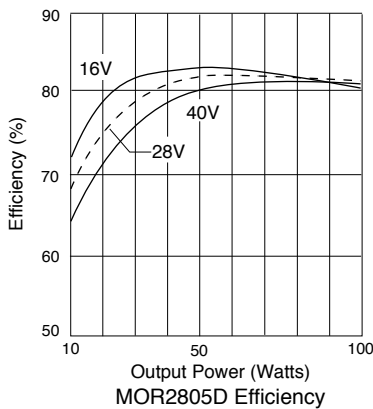

FIGURE 21

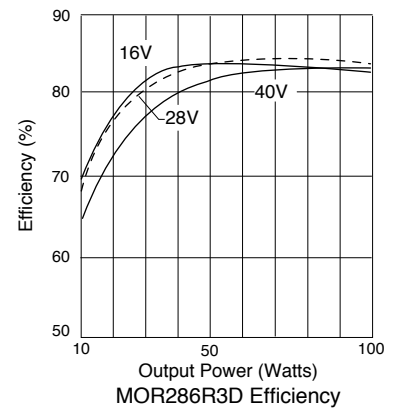

FIGURE 22

# MOR Single and Dual DC/DC Converters

## 28 VOLT INPUT – 120 WATT

Typical Performance Curves: 25°C T<sub>C</sub>, 28 VDC Vin, 100% load, free run, unless otherwise specified.

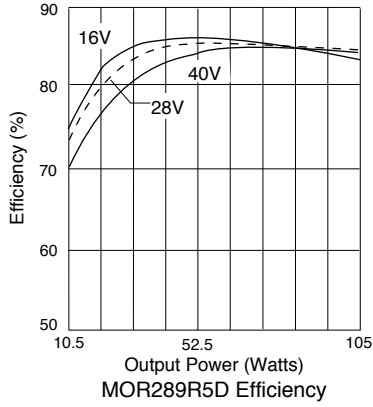

FIGURE 23

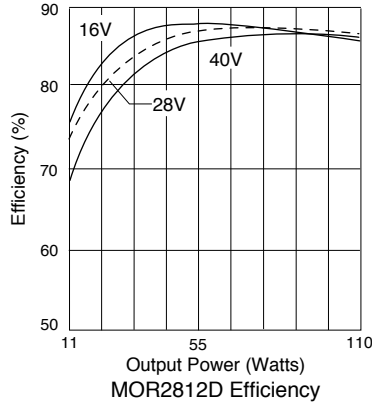

FIGURE 24

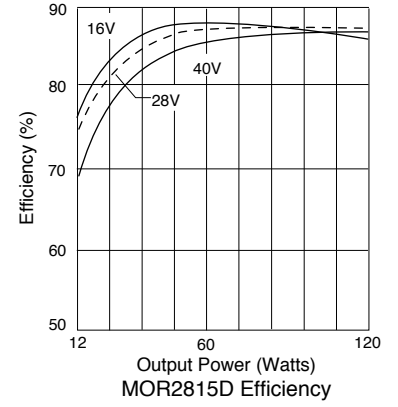

FIGURE 25

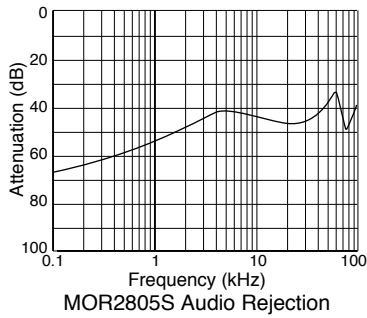

FIGURE 26

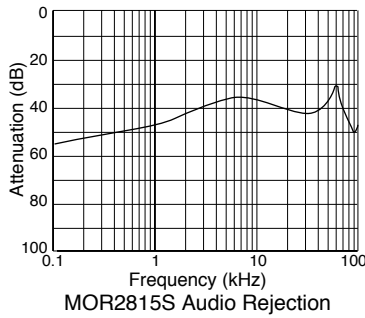

FIGURE 27

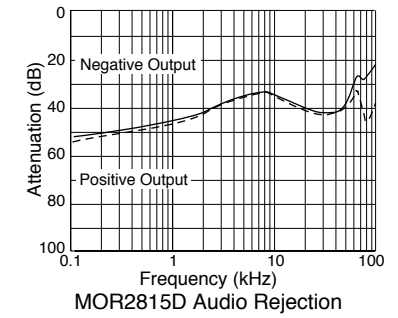
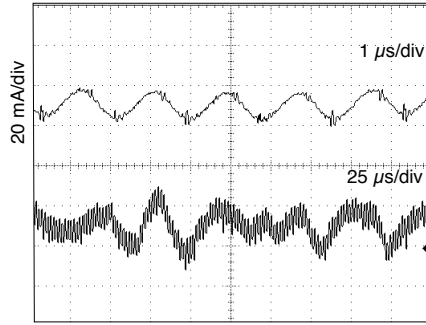

FIGURE 28



Representative of all models  
MOR2812D Sync Out

FIGURE 29



MOR2805S Input Ripple Current (Iin)

FIGURE 30

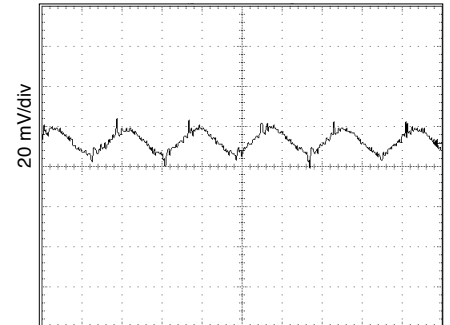

MOR2805S Output Ripple (Vout)

FIGURE 31

# MOR Single and Dual DC/DC Converters

## 28 VOLT INPUT – 120 WATT

Typical Performance Curves: 25°C T<sub>C</sub>, 28 VDC Vin, 100% load, free run, unless otherwise specified.

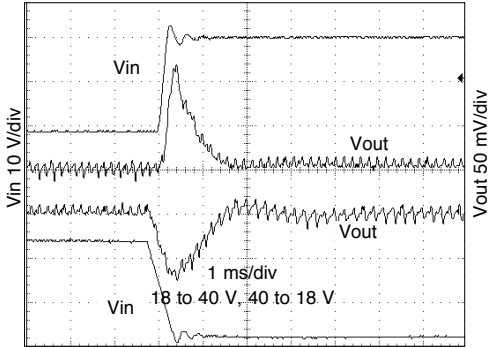

MOR2805S Step Line Response  
FIGURE 32

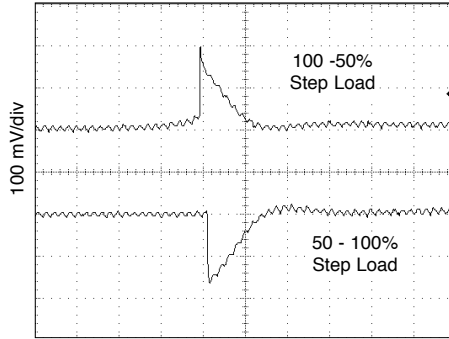

100 μs/div  
MOR2805S Step Load Response  
FIGURE 33

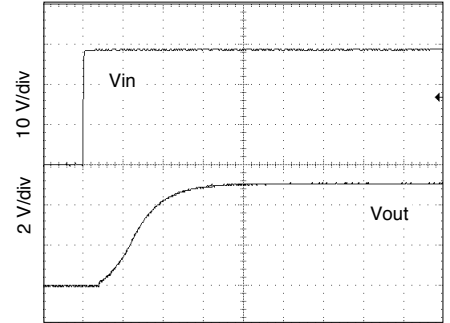

All combinations of line and load  
MOR2805S Turn On Response  
FIGURE 34

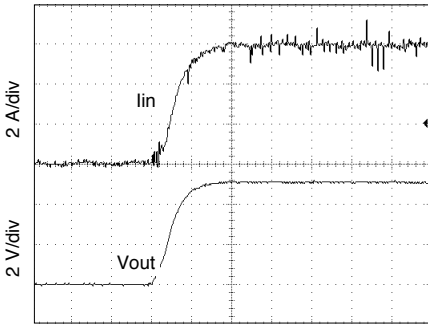

5 ms/div  
With and without 470 μF cap. load  
MOR2805S Inhibit Release Inrush Current  
FIGURE 35

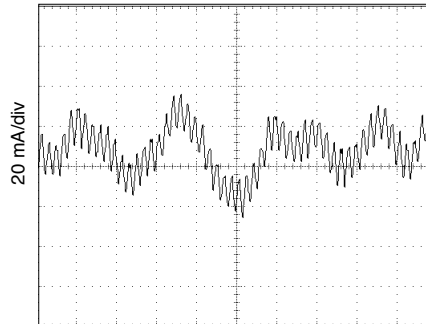

10 μs/div  
MOR2815S Input Ripple (Iin)  
FIGURE 36

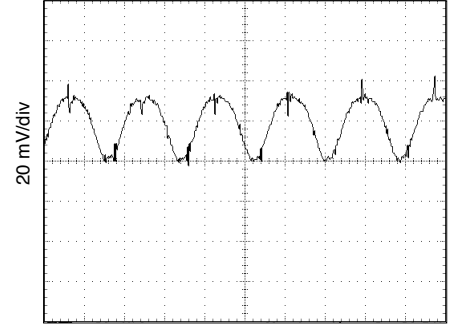

1 μs/div  
MOR2815S Output Ripple (Vout)  
FIGURE 37

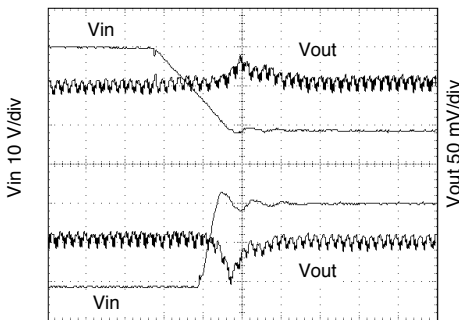

50 μs/div  
18 to 40 V, 40 to 18 V, 50% load  
MOR2815S Step Line Response  
FIGURE 38

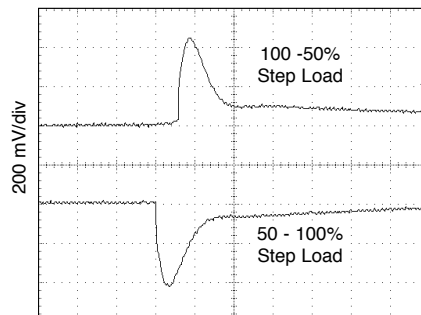

100 μs/div  
MOR2815S Step Load Response  
FIGURE 39

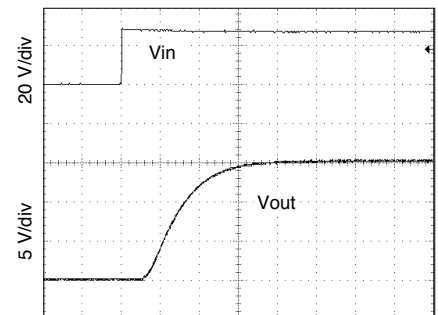

2.5 ms/div  
All combinations of line and load  
MOR2815S Turn On Response  
FIGURE 40

# MOR Single and Dual DC/DC Converters

## 28 VOLT INPUT – 120 WATT

Typical Performance Curves: 25°C T<sub>C</sub>, 28 VDC Vin, 100% load, free run, unless otherwise specified.

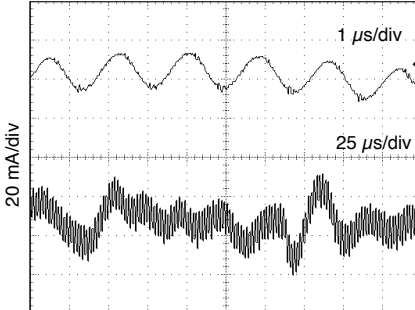

80% load each output  
MOR2805D Input Ripple (lin)

FIGURE 41

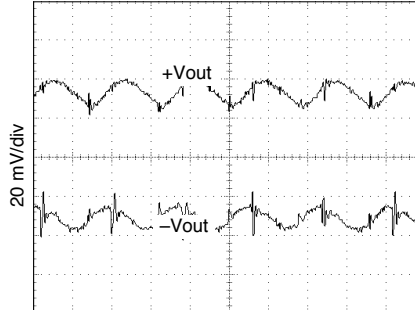

1 μs/div  
80% load each output  
MOR2805D Output Ripple (±Vout)

FIGURE 42

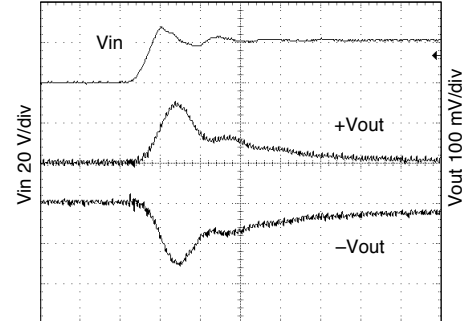

25 μs/div  
18 to 40 V, 80% load each output  
MOR2805D Step Line Response

FIGURE 43

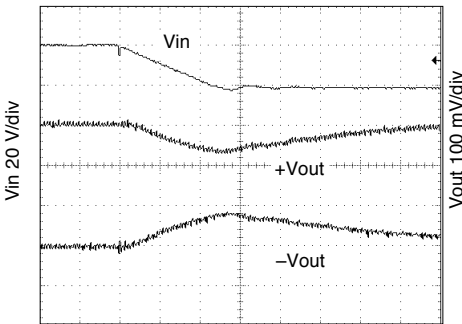

25 μs/div  
40 to 18 V, 80% load each output  
MOR2805D Step Line Response

FIGURE 44

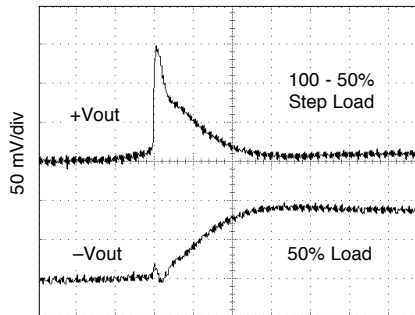

50 μs/div  
MOR2805D Step Load Response

FIGURE 45

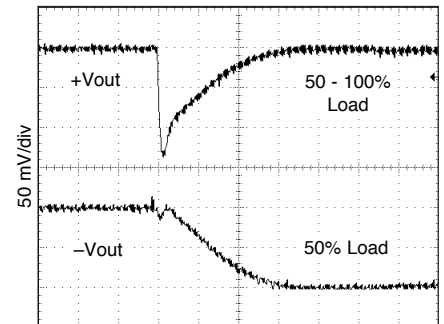

MOR2805D Step Load Response

FIGURE 46

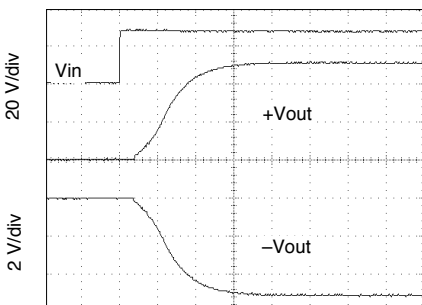

2.5 ms/div  
80% load each output  
MOR2805D Turn On Response

FIGURE 47

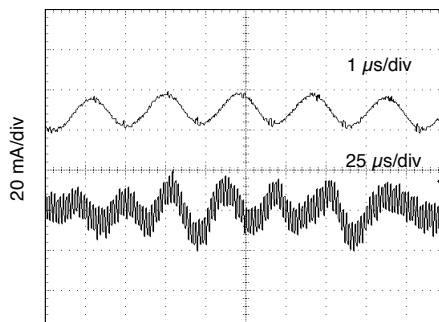

MOR2812D Input Ripple (lin)

FIGURE 48

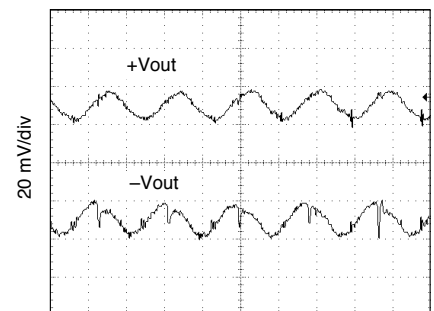

MOR2812D Output Ripple (±Vout)

FIGURE 49



# MOR Single and Dual DC/DC Converters

## 28 VOLT INPUT – 120 WATT

Typical Performance Curves: 25°C T<sub>C</sub>, 28 VDC Vin, 100% load, free run, unless otherwise specified.

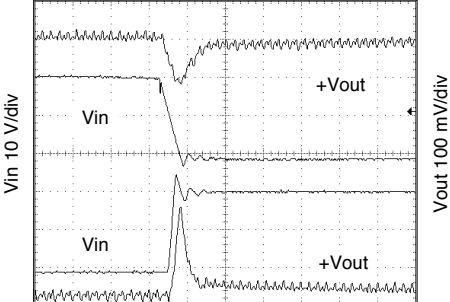

100  $\mu$ s/div  
18 to 40 V, 40 to 18 V  
MOR2812D Step Line Response  
FIGURE 50

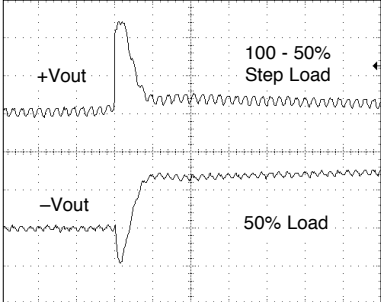

100  $\mu$ s/div  
MOR2812D Step Load Response  
FIGURE 51

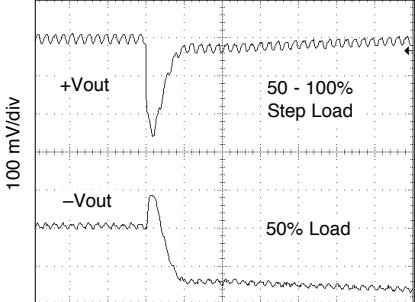

100  $\mu$ s/div  
MOR2812D Step Load Response  
FIGURE 52

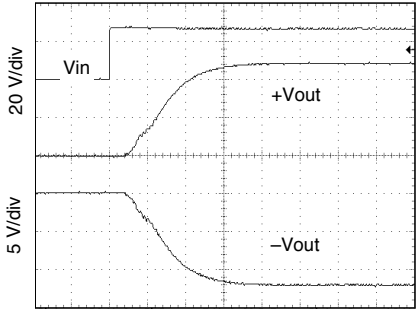

2.5 ms/div  
MOR2812D Turn On Response  
FIGURE 53

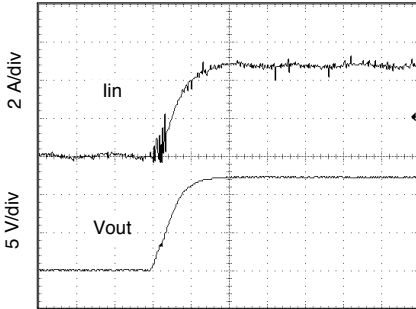

5 ms/div  
MOR2812D Inhibit Release Inrush Current  
FIGURE 54

# MOR Single and Dual DC/DC Converter Cases

## 28 VOLT INPUT – 120 WATT

### TOP VIEW CASE U2 Flanged case, short leads

Case U2 does not require designator in Case Option position of model number for the MOR family

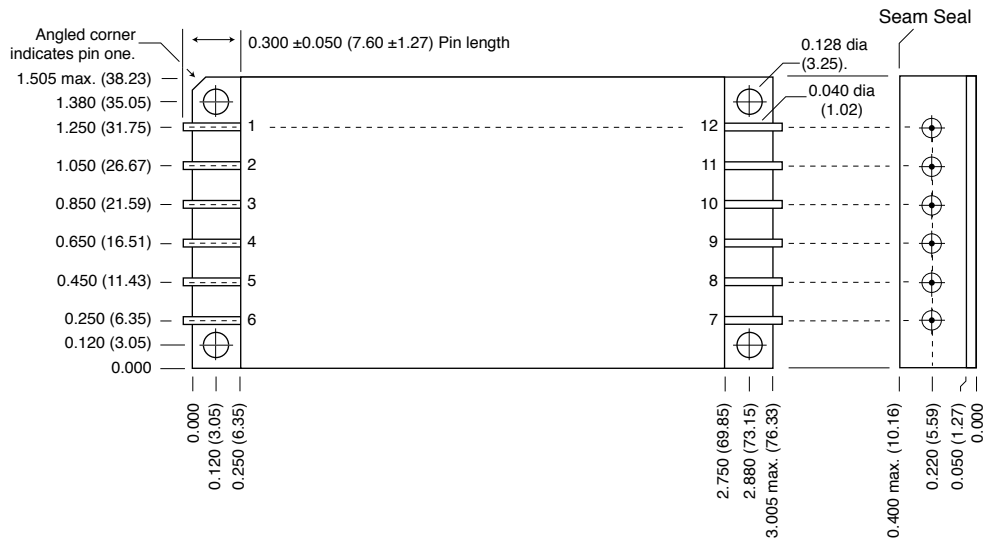

#### Case dimensions in inches (mm)

Tolerance  $\pm 0.005$  (0.13) for three decimal places  
 $\pm 0.01$  (0.3) for two decimal places  
 unless otherwise specified

#### CAUTION

Heat from reflow or wave soldering may damage the device. Solder pins individually with heat application not exceeding 300°C for 10 seconds per pin.

#### Materials

Header Cold Rolled Steel/Nickel/Gold  
 Cover Kovar/Nickel  
 Pins #52 alloy/Gold, compression glass seal  
 Seal Hole: 0.100 ± 0.002 (2.54 ± 0.05)

Case U2, Rev E, 20100401

Please refer to the numerical dimensions for accuracy. All information is believed to be accurate, but no responsibility is assumed for errors or omissions. Interpoint reserves the right to make changes in products or specifications without notice.  
 Copyright © 1999-2010 Interpoint Corp. All rights reserved.

FIGURE 55: CASE U2

# MOR Single and Dual DC/DC Converter Cases

## 28 VOLT INPUT – 120 WATT

### TOP VIEW CASE V\* Flanged case, down leaded

\*Designator "V" required in Case Option position of model number.

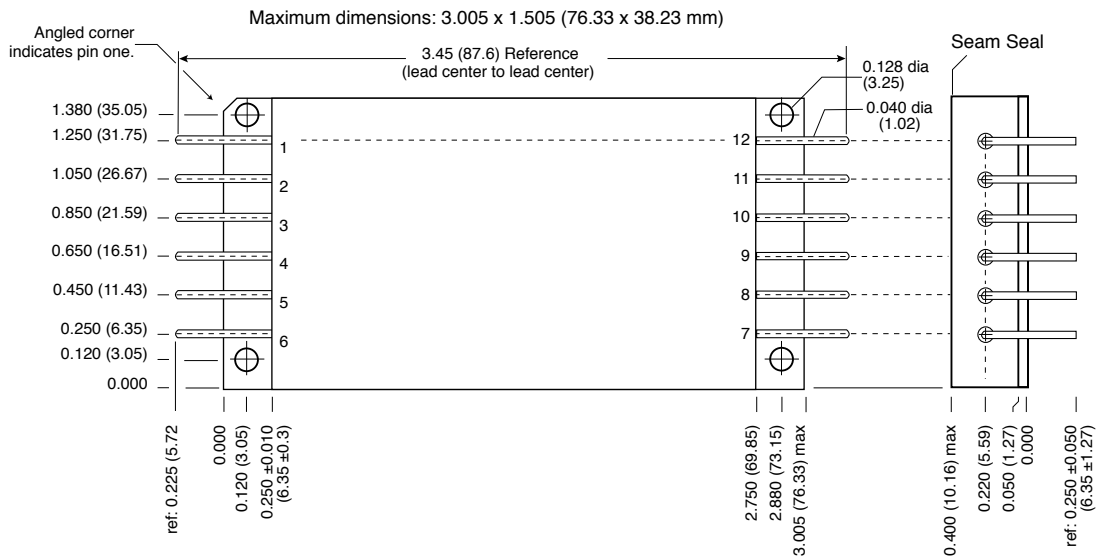

#### Case dimensions in inches (mm)

Tolerance ±0.005 (0.13) for three decimal places  
±0.01 (0.3) for two decimal places  
unless otherwise specified

#### CAUTION

Heat from reflow or wave soldering may damage the device. Solder pins individually with heat application not exceeding 300°C for 10 seconds per pin.

#### Materials

Header Cold Rolled Steel/Nickel/Gold  
Cover Kovar/Nickel  
Pins #52 alloy/Gold, compression glass seal  
Seal Hole: 0.120 ±0.002 (3.05 ±0.05)

Case V, Rev E, 20100106

Please refer to the numerical dimensions for accuracy. All information is believed to be accurate, but no responsibility is assumed for errors or omissions. Interpoint reserves the right to make changes in products or specifications without notice.  
Copyright © 1999-2009 Interpoint Corp. All rights reserved.

FIGURE 56: CASE V

# MOR Single and Dual DC/DC Converter Cases

## 28 VOLT INPUT – 120 WATT

### TOP VIEW CASE W\* Tabbed case, up-ledged

\*Designator "W" required in Case Option position of model number.

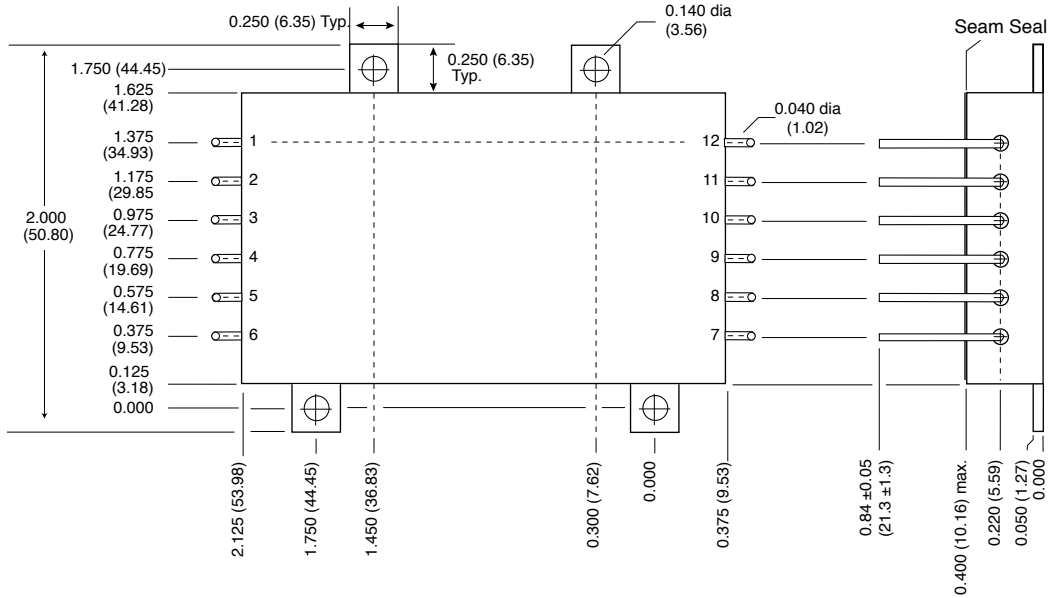

**Case dimensions in inches (mm)**

Tolerance  $\pm 0.005$  (0.13) for three decimal places  
 $\pm 0.01$  (0.3) for two decimal places  
 unless otherwise specified

**CAUTION**

Heat from reflow or wave soldering may damage the device. Solder pins individually with heat application not exceeding 300°C for 10 seconds per pin.

**Materials**

- Header Cold Rolled Steel/Nickel/Gold
- Cover Kovar/Nickel
- Pins #52 alloy/Gold, compression glass seal
- Seal Hole:  $0.120 \pm 0.002$  (3.05  $\pm$  0.05)

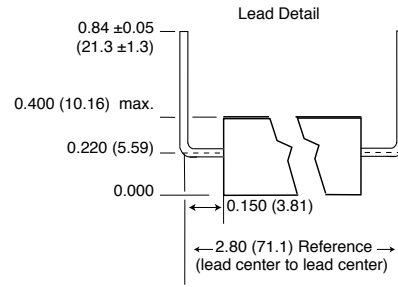

Case W, Rev E, 20100401

Please refer to the numerical dimensions for accuracy. All information is believed to be accurate, but no responsibility is assumed for errors or omissions. Interpoint reserves the right to make changes in products or specifications without notice.

FIGURE 57: CASE W

# MOR Single and Dual DC/DC Converter Cases

## 28 VOLT INPUT – 120 WATT

### TOP VIEW CASE Y\* Tabbed case, straight-leaded

\*Designator "Y" required in Case Option position of model number.

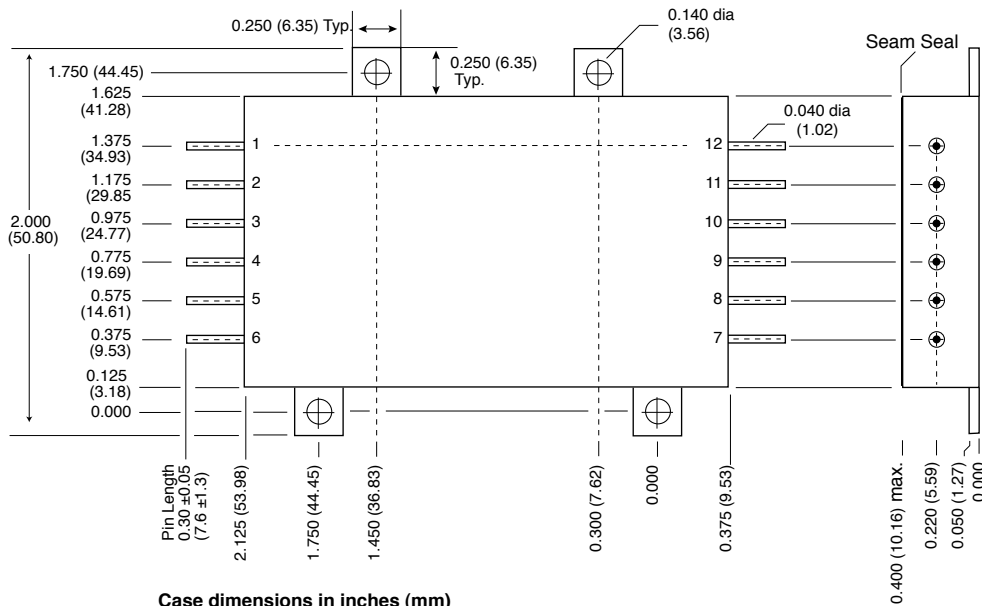

**Case dimensions in inches (mm)**

Tolerance  $\pm 0.005$  (0.13) for three decimal places  
 $\pm 0.01$  (0.3) for two decimal places  
 unless otherwise specified

**CAUTION**

Heat from reflow or wave soldering may damage the device. Solder pins individually with heat application not exceeding 300°C for 10 seconds per pin.

**Materials**

- Header Cold Rolled Steel/Nickel/Gold
- Cover Kovar/Nickel
- Pins #52 alloy/Gold, compression glass seal
- Seal Hole:  $0.120 \pm 0.002$  (3.05  $\pm$  0.05)

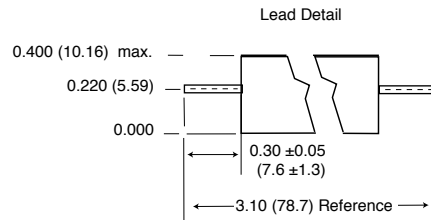

Case Y, Rev E, 20100420

Please refer to the numerical dimensions for accuracy. All information is believed to be accurate, but no responsibility is assumed for errors or omissions. Interpoint reserves the right to make changes in products or specifications without notice. Copyright © 1999-2010 Interpoint Corp. All rights reserved.

FIGURE 58: CASE Y

# MOR Single and Dual DC/DC Converter Cases

## 28 VOLT INPUT – 120 WATT

### TOP VIEW CASE Z\* Tabbed case, down-leaded

\*Designator "Z" required in Case Option position of model number.

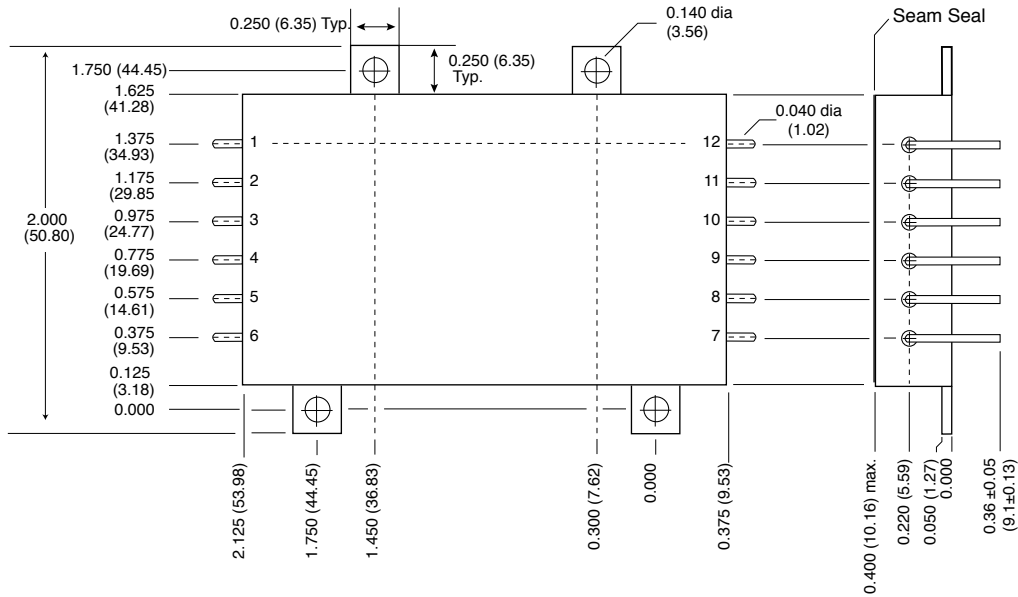

**Case dimensions in inches (mm)**

Tolerance  $\pm 0.005$  (0.13) for three decimal places  
 $\pm 0.01$  (0.3) for two decimal places  
 unless otherwise specified

**CAUTION**

Heat from reflow or wave soldering may damage the device. Solder pins individually with heat application not exceeding 300°C for 10 seconds per pin.

**Materials**

- Header Cold Rolled Steel/Nickel/Gold
- Cover Kovar/Nickel
- Pins #52 alloy/Gold, compression glass seal
- Seal Hole:  $0.120 \pm 0.002$  (3.05  $\pm 0.05$ )

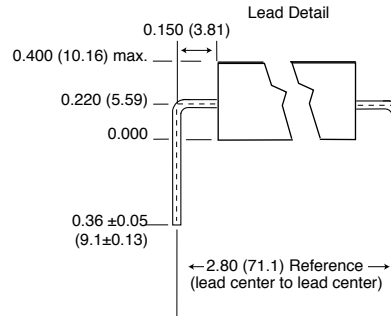

Case Z, Rev E, 20100401

Please refer to the numerical dimensions for accuracy. All information is believed to be accurate, but no responsibility is assumed for errors or omissions. Interpoint reserves the right to make changes in products or specifications without notice. Copyright © 1999-2010 Interpoint Corp. All rights reserved.

FIGURE 59: CASE Z

# MOR Single and Dual DC/DC Converters

## 28 VOLT INPUT – 120 WATT

### STANDARD AND /ES (NON-QML) AND /883 (CLASS H, QML) PRODUCT ELEMENT EVALUATION

COMPONENT-LEVEL TEST PERFORMED	STANDARD AND /ES NON-QML <sup>1</sup>		/883 CLASS H QML	
	M/S <sup>2</sup>	P <sup>3</sup>	M/S <sup>2</sup>	P <sup>3</sup>
Element Electrical (probe)	yes	no	yes	yes
Element Visual	no	no	yes	yes
Internal Visual	no	N/A	yes	N/A
Final Electrical	no	no	yes	yes
Wire Bond Evaluation <sup>4</sup>	no	no	yes	yes
SLAM™/C-SAM: Input capacitors only (Add'l test, not req. by H)	no	no	no	yes

**Notes:**

1. Standard and /ES, non-QML products, do not meet all of the requirements of MIL-PRF-38534.
2. M/S = Active components (Microcircuit and Semiconductor Die)
3. P = Passive components
4. Not applicable to EMI filters that have no wire bonds.

**Definitions:**

Element Evaluation: Component testing/screening per MIL-STD-883 as determined by MIL-PRF-38534  
 SLAM™: Scanning Laser Acoustic Microscopy  
 C-SAM: C - Mode Scanning Acoustic Microscopy

SCREENING TABLE 1: ELEMENT EVALUATION

# MOR Single and Dual DC/DC Converters

## 28 VOLT INPUT – 120 WATT

### STANDARD AND /ES (NON-QML) AND /883 (CLASS H, QML) PRODUCT ENVIRONMENTAL SCREENING

TEST PERFORMED	125°C STANDARD NON-QML <sup>1</sup>	125°C /ES NON-QML <sup>1</sup>	/883 CLASS H QML
Pre-cap Inspection Method 2017, 2032	yes	yes	yes
Temperature Cycle (10 times) Method 1010, Cond. C, -65°C to 150°C, ambient Method 1010, Cond. B, -55°C to 125°C, ambient	no no	no yes	yes no
Constant Acceleration Method 2001, 3000 g Method 2001, 500 g	no no	no yes	yes no
Burn-in <sup>2</sup> Method 1015, 125°C case, typical 96 hours 160 hours	no no	yes no	no yes
Final Electrical Test MIL-PRF-38534, Group A Subgroups 1 through 6: -55°C, +25°C, +125°C case Subgroups 1 and 4: +25°C case	no yes	no yes	yes no
Hermeticity Test Fine Leak, Method 1014, Cond. A Gross Leak, Method 1014, Cond. C Gross Leak, Dip (1 x 10 <sup>-3</sup> )	no no yes	yes yes no	yes yes no
Final visual inspection Method 2009	yes	yes	yes

Test methods are referenced to MIL-STD-883 as determined by MIL-PRF-38534.

Notes:

- Standard and /ES, non-QML products, do not meet all of the requirements of MIL-PRF-38534.
- Burn-in temperature designed to bring the case temperature to +125°C

SCREENING TABLE 2: ENVIRONMENTAL SCREENING